

**Camera Connector
SDR 6 o'clock type**

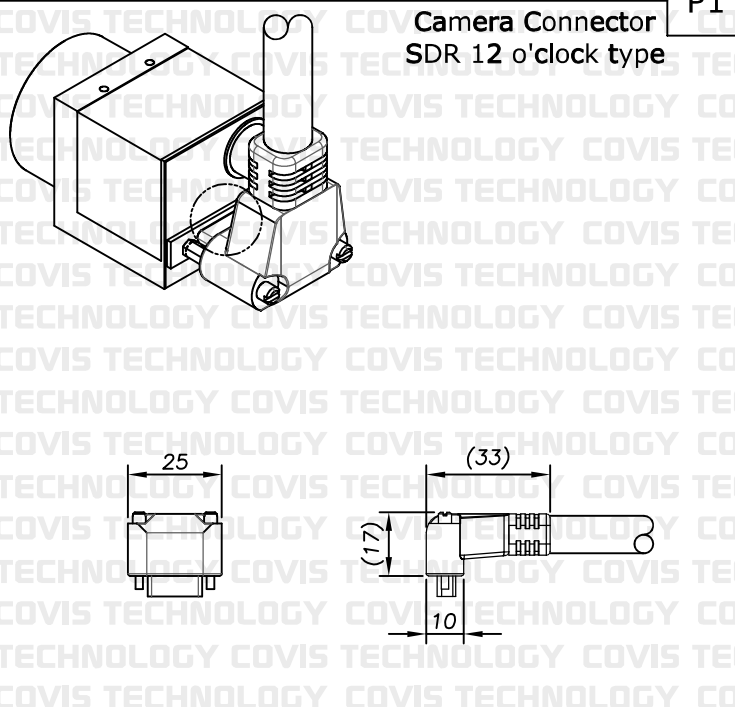

**Camera Connector
SDR 12 o'clock type**

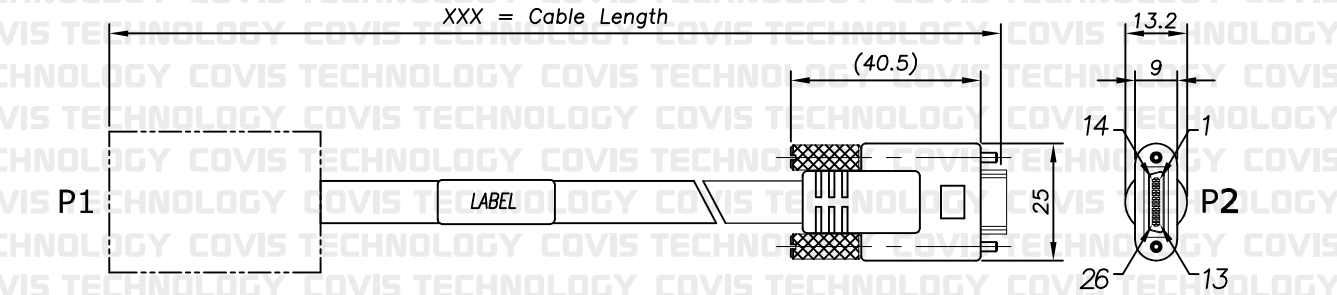
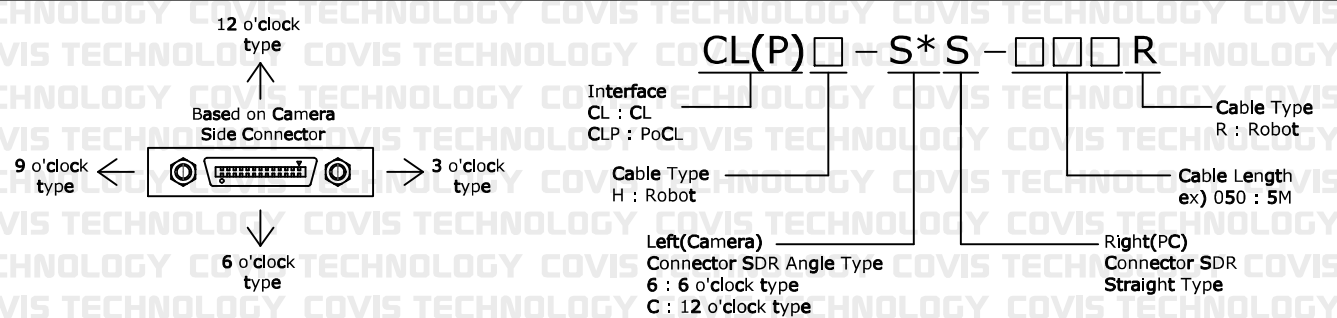

UNIT	mm	DWG.	CYS	ITEM	CAMERA LINK CABLE
DATE	2024.05.16	APPROVAL		PART NO.	CL(P)*-S*S-***R