

Angle Type

P1

12 o'clock type
↑

Based on Camera Side Male Connector

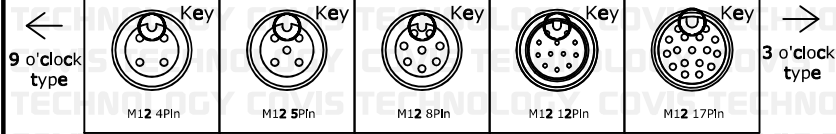

↓
6 o'clock type

Camera Connector
3 o'clock type

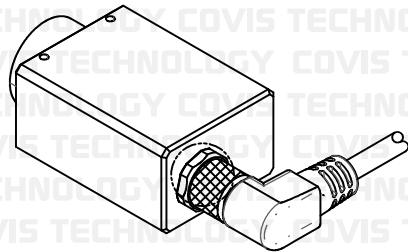

Camera Connector
9 o'clock type

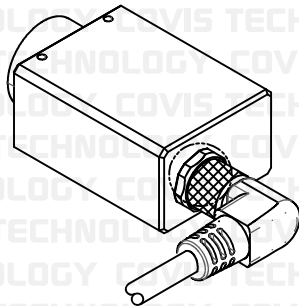

Camera Connector
6 o'clock type

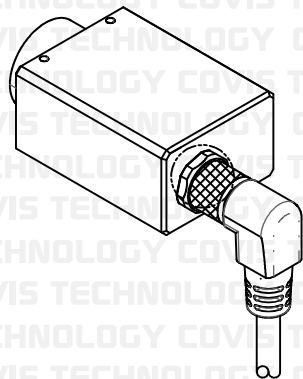

Camera Connector
12 o'clock type

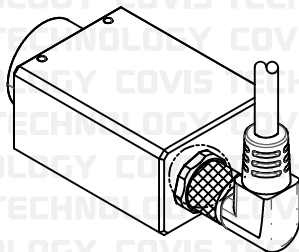

M12IO-□-□F□-□-□□□□

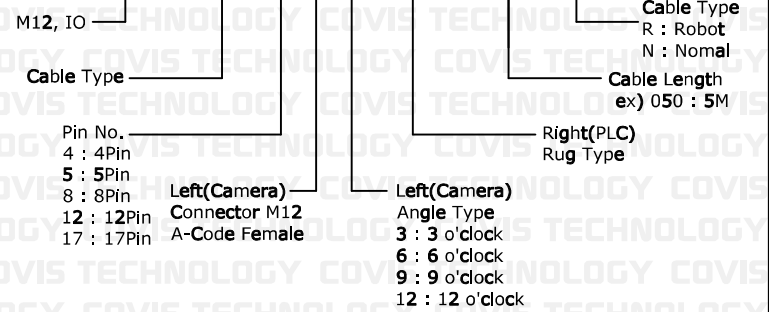

XXX = Cable Length

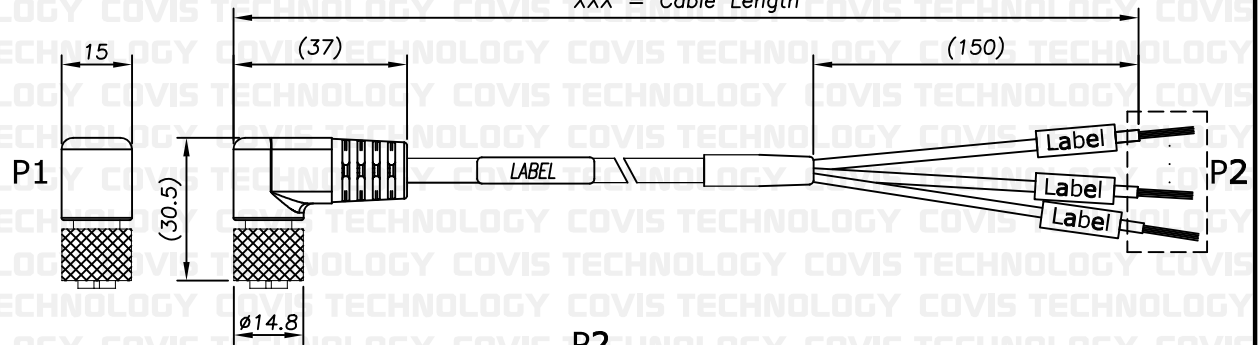

P2

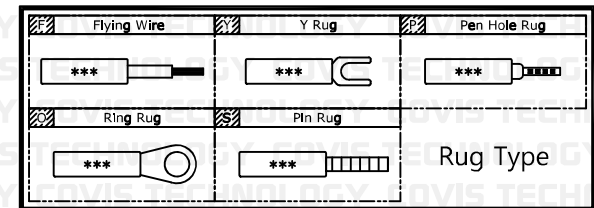

UNIT	mm	DWG.	CYS	ITEM	WATER PROOF CONNECTOR
DATE	2024.05.27	APPROVAL		PART NO.	M12IO-**-F**-**-**R(N)