

Angle Type

P1

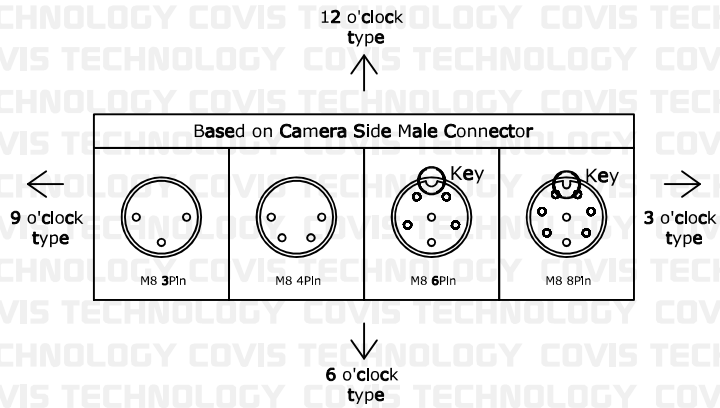

Camera Connector
3 o'clock type

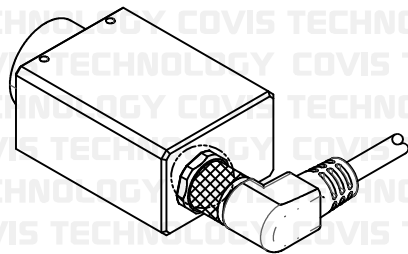

Camera Connector
9 o'clock type

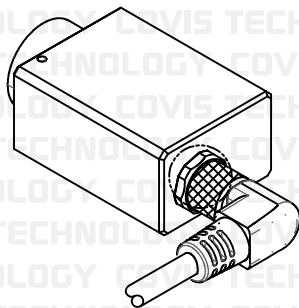

Camera Connector
6 o'clock type

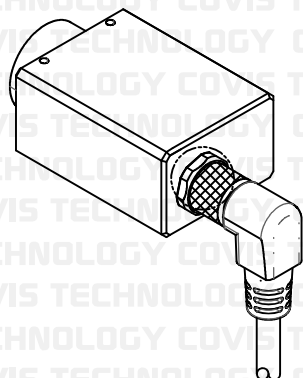

Camera Connector
12 o'clock type

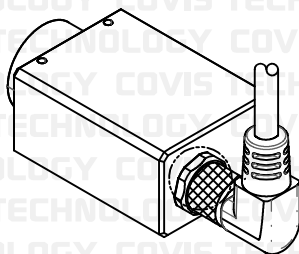

M8IO-□-□F□-□-□□□□

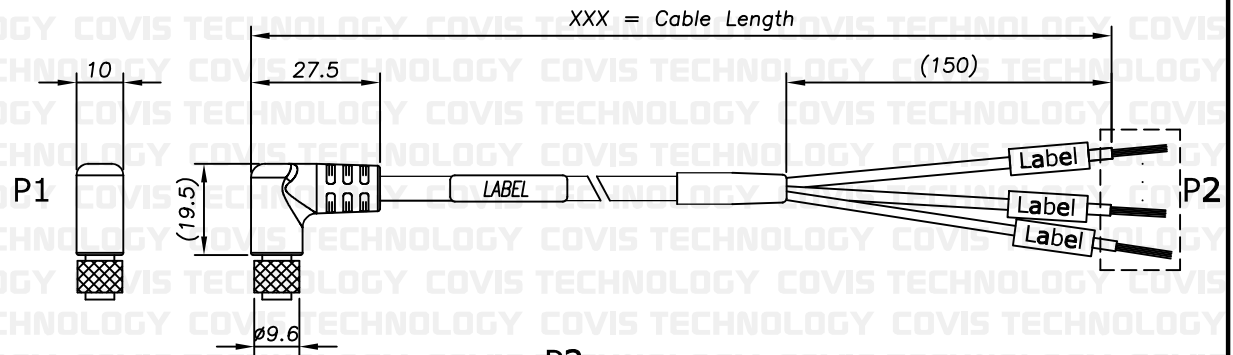
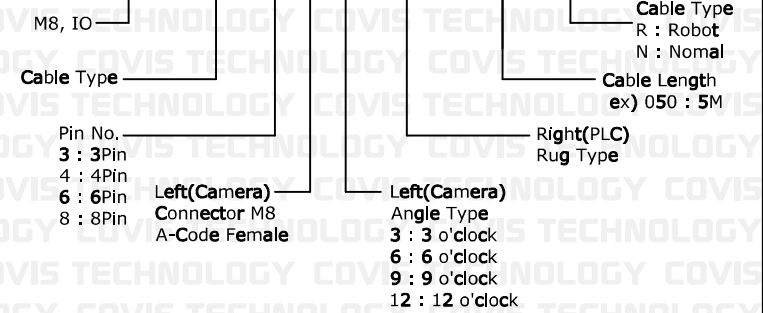

P2

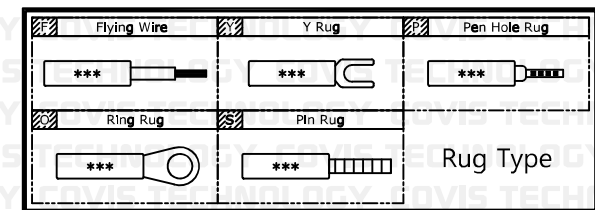

UNIT	mm	DWG.	CYS	ITEM	WATER PROOF CONNECTOR
DATE	2024.05.27	APPROVAL		PART NO.	M8IO-_*F*_**R(N)