

**Camera Connector
micro-B 6 o'clock type**

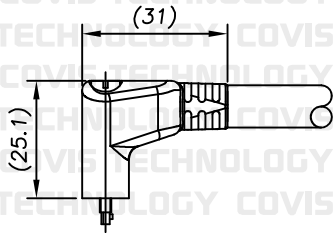

P1

**Camera Connector
micro-B 12 o'clock type**

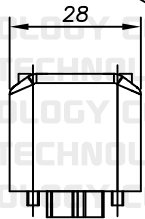
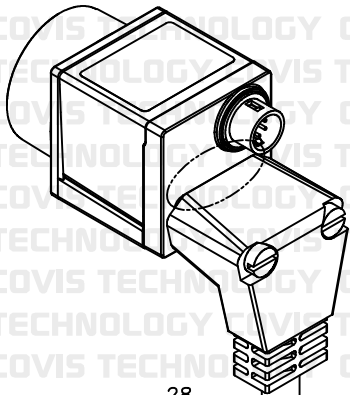
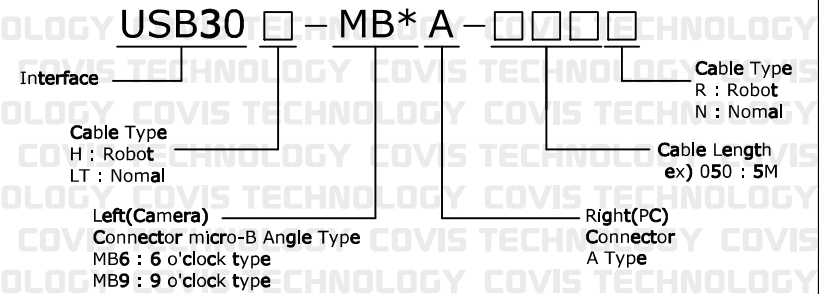
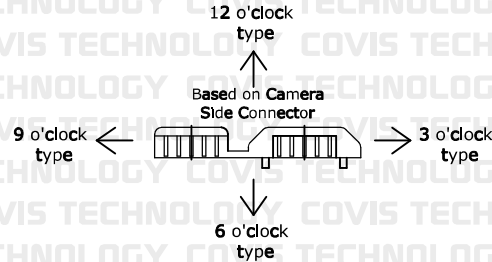
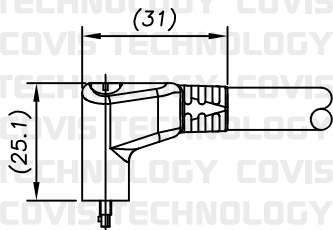
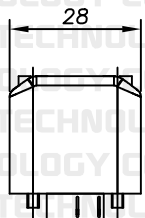
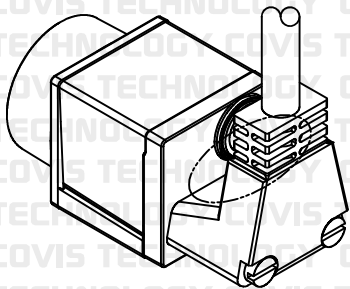

XXX = Cable Length

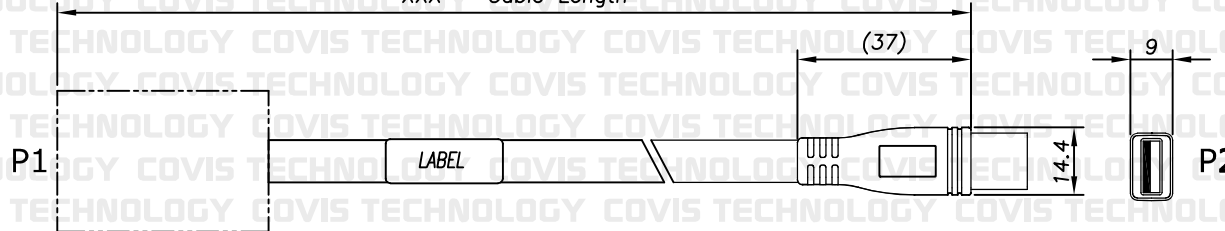

UNIT	mm	DWG.	CYS	ITEM	USB3.0 CABLE
DATE	2024.05.16	APPROVAL		PART NO.	USB30*-MB*A-***R(N)