

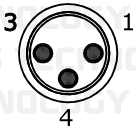
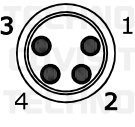
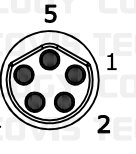
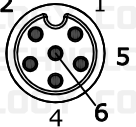
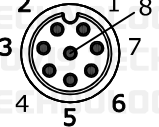
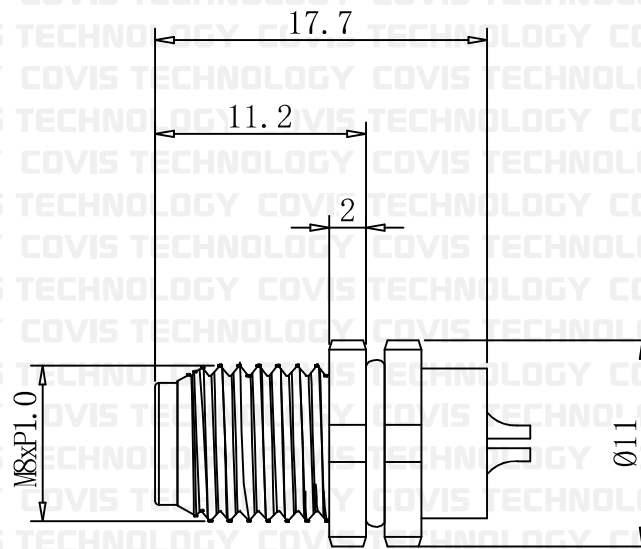
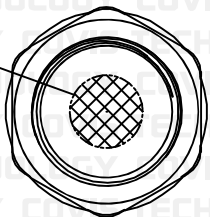

M8 Male Connector

Pin

 <p>A-Code 3Pin</p>	 <p>A-Code 4Pin</p>	 <p>B-Code 5Pin</p>	 <p>A-Code 6Pin</p>	 <p>A-Code 8Pin</p>
--	--	--	---	--

Pin



UNIT	mm	DWG.	CYS	ITEM	WATER PROOF CONNECTOR
DATE	2024.08.16	APPROVAL		PART NO.	M8 Male Connector (Mount Type - Front Solder)
 COVIS Technology Co., Ltd					