

M9 Male Connector

Pin

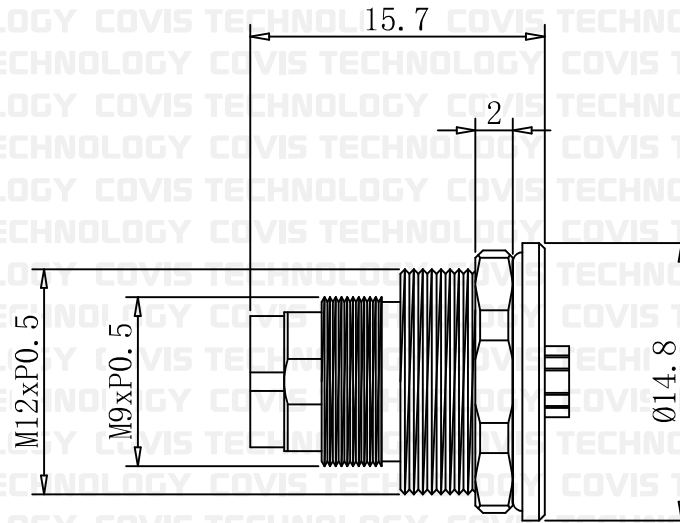

Hole Size

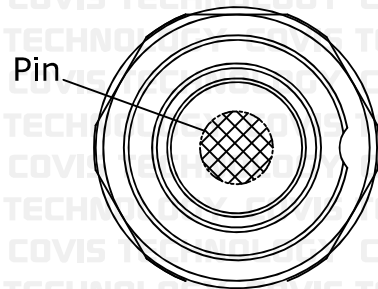
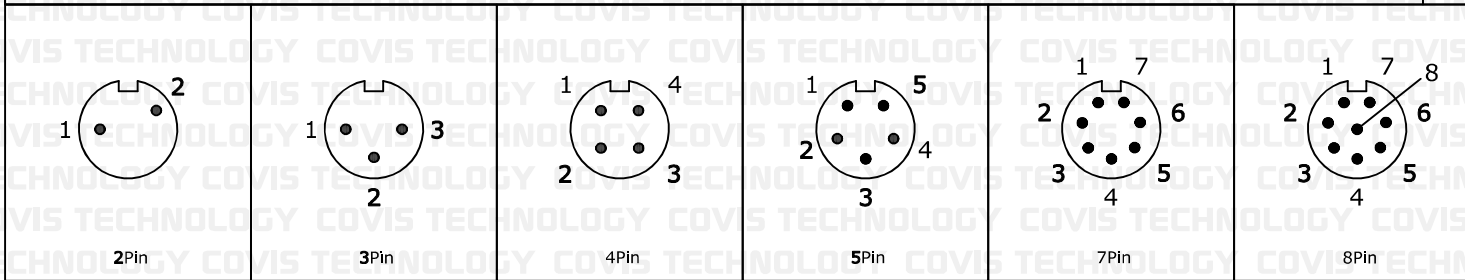
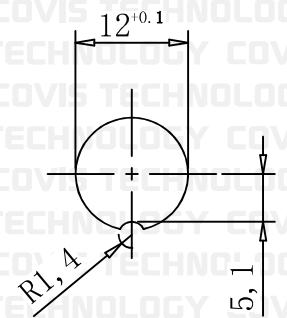

UNIT	mm	DWG.	CYS	ITEM	WATER PROOF CONNECTOR
DATE	2024.08.16	APPROVAL		PART NO.	M9 Male Connector (Mount Type - Front Solder)
COVIS Technology Co., Ltd					